

BLU-C Series

Battery Load Unit

- Operating voltage range: 3,0 (0,0) * ** - **800 V DC**
 * Discharge down to 0 V available as optional feature
 ** Efficient discharge to 0 V available with ZVD module
- Discharge current - up to **300 A DC**
- Discharge power - up to **42,0 kW**
- Real-time test parameters monitoring on **7 inch touch screen display**
- Enables total battery discharge prior recycling
- Provides temperature controlled discharge process
- Enables testing batteries while in service
- Test resume feature in case of interrupted power supply



Description

DV Power BLU-C Battery Capacity Tester is the latest DV Power solution for comprehensive battery capacity measurement. This universal instrument is applicable to any battery string (lead-acid, lithium-ion, nickel-cadmium based or other) with voltages **up to 800 V DC**.

The BLU-C capacity tester simplifies battery testing. It provides monitoring of discharge parameters (graphical and numerical) on **7 inch touch screen display**. Parameters such as battery voltage, capacity, test current / power / resistance and elapsed time can be monitored in real time. As an addition, the instrument enables measurement and monitoring of cell parameters (voltage/intercell voltage/temperature) with BVS system, which makes it a complete stand-alone discharge test system. The capacity tester can also be used with DV-B Win software, enabling detailed numerical and graphical presentation of key parameters, including report creating in various formats.

Using the BLU-C device, the capacity test is performed in an accurate, user-friendly way in accordance to actual standards for battery

testing (IEEE 450-2010 / IEEE 1188-2005 / IEEE 1106-2015, IEC 60896-11/22 and other).

BLU-C enables battery discharge down to 0 V (optional feature). Additionally, when combined with Zero Voltage Discharge Module ZVD, BLU-C enables fast and efficient **full battery discharge down to 0 V**, required before battery recycling.

Discharging can be performed at constant current, constant power, constant resistance, constant voltage or in accordance with a pre-selected load profile. The discharge test can be carried out on online batteries as well (connected to its load). By measuring the total or load current by a DC probe, BLU-C enables keeping the total current / power constant during the test.

When a required discharge current or power exceeds the capacity of a single BLU-C device, several identical BLU-C models can be connected in parallel. Alternatively, External Load Units BXL Series can also be used to increase discharging capacity.

Models Overview

Model	BLU100C	BLU200C	BLU300C	BLU400C	BLU500C	BLU570C	BLU600C	BLU700C	BLU800C
I_{max} (A)	150	300	220	300	220	100	300	260	100
U_{max} (V)*	300	300	300	300	500	570	500	705	800
P_{max} (kW)	20	42	20	42	20	30	42	42	32
BVS functionality**	NO	NO	YES	YES	YES	YES	YES	YES	YES
Parallel operation***	NO	NO	YES	YES	YES	YES	YES	YES	YES

* Maximum operating voltage.

** Individual cell voltage monitoring feature.

*** Parallel operation of 2 or more same model BLU-C units without external current measurement

Batt. voltage (V)		Maximum currents (A) to 1.85 V / cell								
Nom.	Min / Max	BLU100C	BLU200C	BLU300C	BLU400C	BLU500C	BLU600C	BLU570C	BLU700C	BLU800C
3,6	3,2	-	-	-	-	-	-	-	50	-
	4,2	-	-	-	-	-	-	-	50	-
6	5,55	40	50	55	50	55	50	20	50	20
	7,05	40	50	55	50	55	50	20	50	20
12	11,1	100	100	115	100	115	100	40	60	40
	14,1	100	100	115	100	115	100	40	60	40
24	22,2	150	200	185	200	185	200	80	120	80
	28,2	150	200	185	200	185	200	80	120	80
48	44,4	150	200	220	200	220	200	100	120	100
	56,4	150	200	220	200	220	200	100	120	100
60	55,5	150	200	220	200	220	200	100	120	100
	70,5	150	200	220	200	220	200	100	120	100
110	101,75	120	300	150	300	150	300	100	240	100
	129,25	120	300	150	300	150	300	100	240	100
120	111,0	120	300	140	300	140	300	100	260	100
	141,0	120	300	140	300	140	300	100	260	100
220	203,5	75	150	75	150	75	150	100	100	100
	258,5	75	150	75	150	75	150	100	100	100
240	222,0	70	150	70	150	70	150	100	110	100
	300,0	70	150	70	150	70	150	100	110	100
420	388,5	-	-	-	-	40	65	50	80	50
	493,5	-	-	-	-	40	65	50	80	50
480	444,0	-	-	-	-	-	-	50	70	50
	564,0	-	-	-	-	-	-	50	70	50
600	555,0	-	-	-	-	-	-	-	60	50
	705,0	-	-	-	-	-	-	-	60	50
640	592,0	-	-	-	-	-	-	-	-	40
	800,0	-	-	-	-	-	-	-	-	40
Weight (kg / lbs)		18,9 / 41.6	28,5 / 62.7	18,9 / 41.6	28,5 / 62.7	18,9 / 41.6	28,5 / 62.7	20,8 / 45.8	28,0 / 61.7	20,8 / 45.8

Application

Typical application is measuring the capacity of batteries up to 800 V DC. Additionally, BLU-C (with and without ZVD) enables full discharge of the battery (down to 0 V DC).

BLU-C can be applied to batteries that can be found in (but not limited to):

- Power plants
- Telecommunication systems
- Generator excitation systems
- Substations
- Protection and control systems

Connecting BLU-C to Battery

Single mode

The BLU-C device can be connected to any battery test object by using a set of current cables and, optionally, a set of voltage sense cables. To maximize the accuracy and measurement repeatability, all clamps must have good connection to the battery terminals while any crossing between the cables should be avoided. The BLU-C displays an appropriate message if connection between a cable clamp and the corresponding battery terminal is not established.

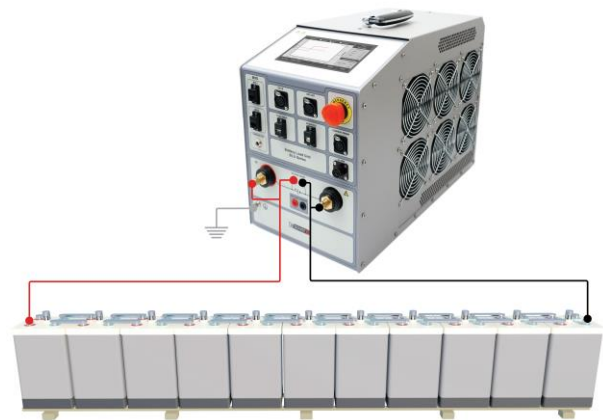

Parallel discharge test mode

In case the required discharge current or power exceeds the capacity of a single BLU-C device, several (up to ten) devices can be connected in parallel. Only identical models can operate in parallel discharge mode.

Connection between BLU-C devices is established by using Ethernet ports and RS485 communication. The communication is based on a MASTER-SLAVE principle – arbitrary selected device is set as MASTER while all the other BLU-C devices should be set as SLAVE units. In the parallel connection the MASTER will discharge as much energy as possible; the remaining energy (discharge current / discharge power) will be discharged on the first SLAVE unit in a chain. If MASTER and the first SLAVE does not have capacity to cover the discharge requirements, the remaining energy will be discharged on the next SLAVE in a chain, etc.

* BLU100C & BLU200C models do not support testing in parallel discharge mode.

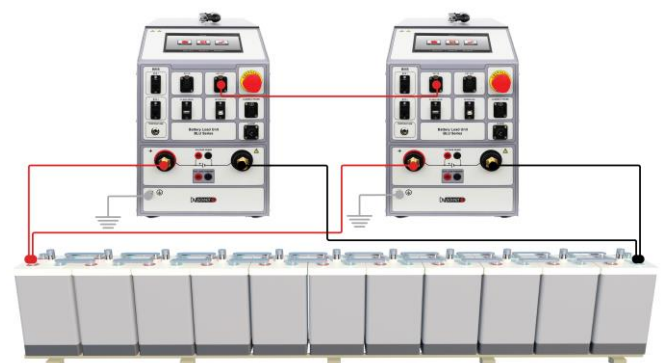

Current Probe mode

If the battery needs to supply its regular load continuously, the load current should be taken into account during the discharge test. Also, testing high-capacity battery strings may require engaging additional load units (such as Extra

Load BXL or any other load units). In both cases, the current probe should be used to enable BLU-C to regulate the total current / power.

The current probe can be connected in one of the following ways:

1. To measure the total discharge current (**Battery current mode**)

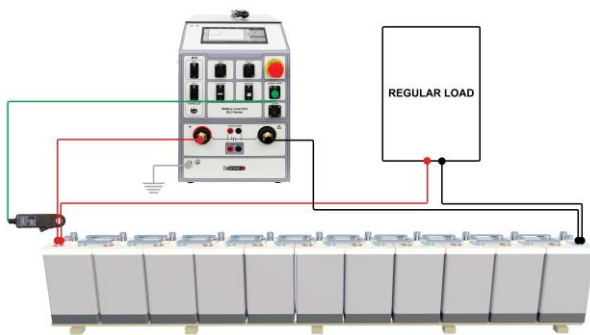

2. To measure the current of all loads, except the BLU-C current (**Load current mode**)

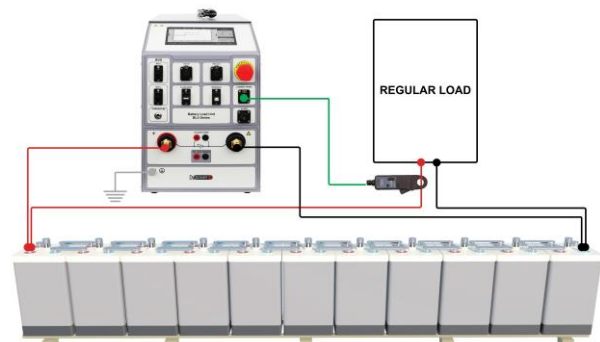

BLU-C + ZVD for Total Discharge (to 0 V)

Zero Voltage Discharge Module ZVD Series is specially designed external module enabling full battery discharge (down to 0 V) required before recycling. It is designed to operate in a system with BLU-C providing total discharge of batteries with voltage up to 800 V DC.

The total battery discharge is required in the battery recycling process. It is important to discharge a battery completely before entering the recycling process, because the battery can contain some remanent energy. That remanent energy can be dangerous and create problems during the disassembling of a battery or even during its transportation. In order to prevent that,

we created the ZVD Series enabling a full battery discharge.

A single discharge down to 0 V will not extract all the energy from the battery. Once the discharge is finished, battery voltage will rise to some non-zero value, confirming there is still energy in the battery. The phenomenon is called the battery voltage rebound.

BLU-C & ZVD system improves the discharge process by discharging the battery in 2 steps:

Step 1: Efficient (up to 60 A) and controlled (current is constant down till 0 V is reached) discharge until battery voltage drops to 0 V.

Step 2: ZVD short-circuits the battery to remove the remaining energy.

Connecting BLU-C & ZVD to Battery

To connect BLU-C and ZVD to a battery string, two sets of current and sense cable sets are required, as well as one set of trigger cable to initiate ZVD operation (short-circuiting the battery). One set of current & sense cables is used to connect BLU-C and ZVD, while the other cable set is connected between ZVD and the battery. The BLU-C displays an appropriate message if cables are not properly connected prior the test. Connecting voltage sense cables to ZVD and to a battery is necessary for proper operation of the system (enabling accurate battery voltage measurement).

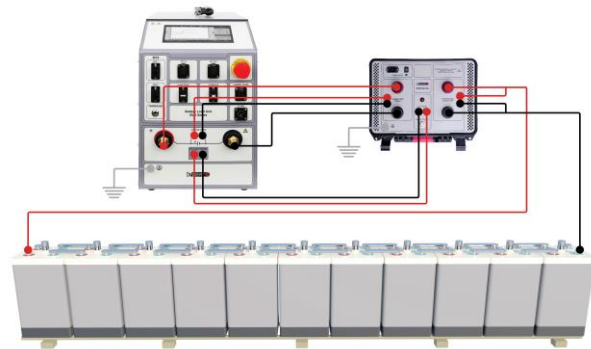

Benefits and Features of BLU-C & ZVD system

- Efficient total battery discharge down to 0 V required before recycling
- Applicable to any battery type: Lead-acid, Ni-Cd, Li-based etc.
- Efficient constant current discharge (up to 60 A) down to 0 V
- Universal models applicable to up to 800 V DC
- Discharge current can be modified during the discharge
- Test can be controlled from device interface or PC DV-B Win software. When controlled from device interface, test result will be saved in the BLU-C internal memory and can be downloaded to a USB and transferred to a PC for analysis and report generation. Key test parameters (battery voltage, current, elapsed time, etc) will be presented in graphical and numerical form.

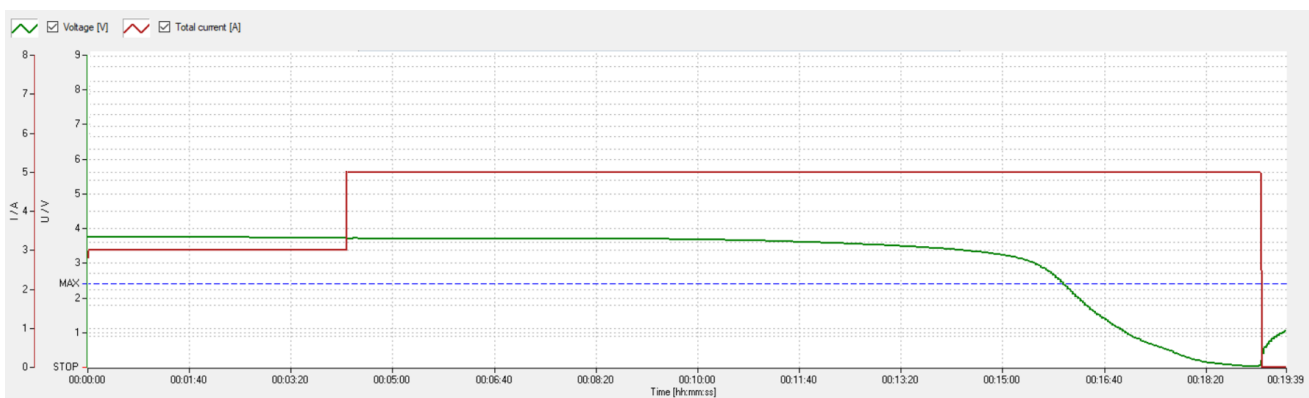

Benefits and Features of BLU-C units

- Battery capacity measurement by conducting a discharge test, in compliance with corresponding IEEE, IEC and other relevant standards
- Battery discharge down to 0 V available. Efficient battery discharge down to 0 V available with external ZVD module
- *Constant I, Constant P, Constant R, Constant U* operation modes
- Several Load profile operation modes: *Load profile I, Load profile P* and *Load profile R*, enable simulating load characteristics variation during a discharge test
- Real-time test parameters monitoring on 7 inch touch screen display, including Voltage / Time and Capacity / Time graphs
- Cell parameters measurement and monitoring via BVS system
- Temperature controlled discharge process
- Parallel operation feature for identical models (*not provided for the BLU100C & BLU200C models*)
- Enables testing batteries while in service
- Test settings can be modified during the test
- Ambient and cell temperature measurement feature
- Test resume feature in case of interrupted power supply
- Results saved in the internal memory can be downloaded to u USB and transferred to a PC for analysis and report generation
- Adjustable alarm and shutdown parameters for preventing excessive discharge

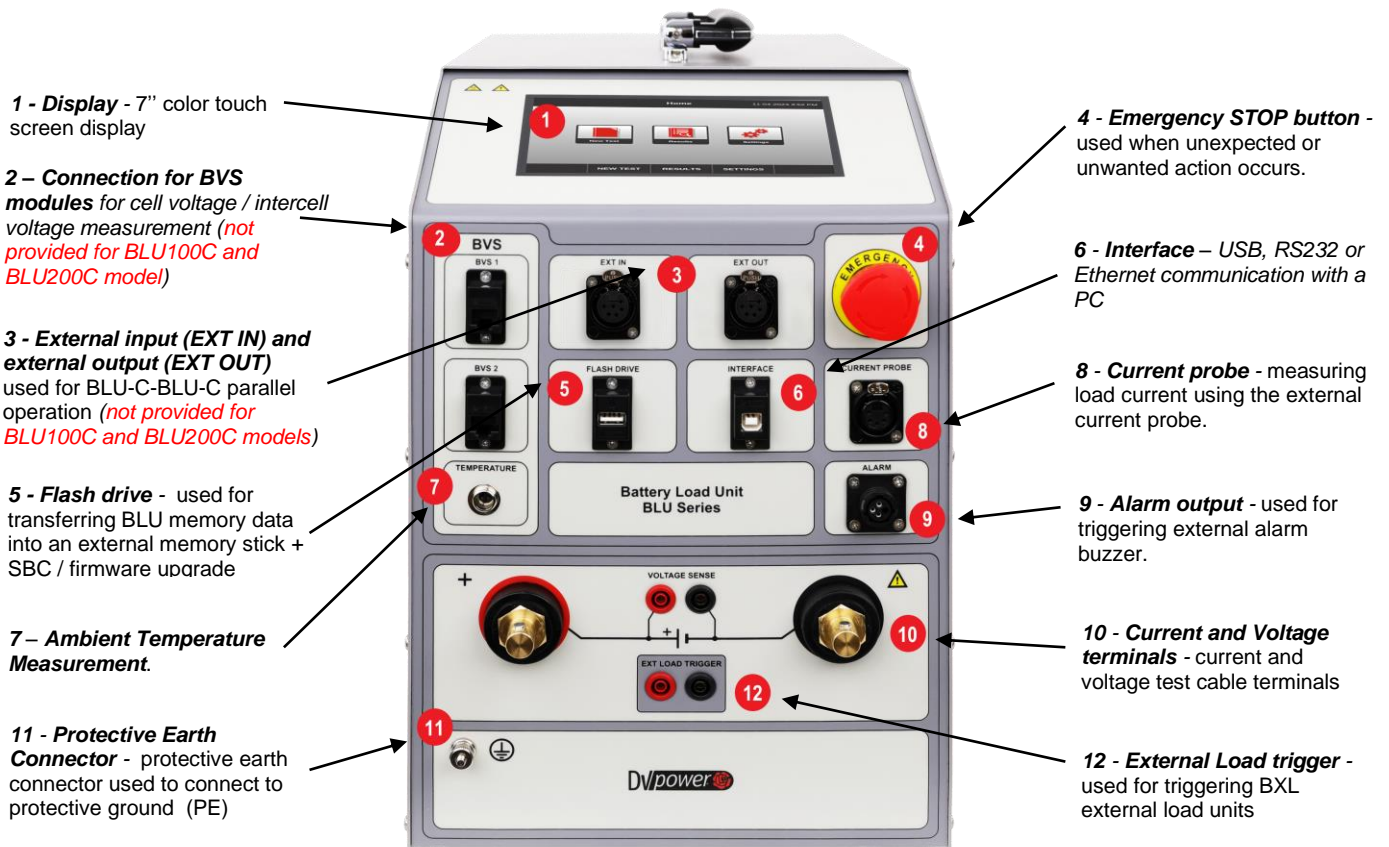



Cell Voltage Measurement Feature

Combining BLU-C and BVS

DV Power battery voltage supervisor – BVS, is an accurate battery voltage monitoring system that monitors the state of health of battery systems. It records important battery parameters such as battery voltage and cell voltage. Therefore, it can be a support tool for BLU-C

during capacity testing. There are two types of DV Power battery voltage supervisors:

- BVS – One cell voltage module measures 1 cell
- BVS-4 – One cell voltage module measures 4 cells

Series	BVS	BVS-4
Picture		
No. of Measured Cells	One module measures one cell	One module measures four cells
Inter-cell Connection Voltage	✓	✗
Cell Temperature	YES (one temperature channel per cell)	YES (one temperature channel per 4 cells)
Ambient Temperature	✓	✓

Connecting BLU-C and CVM / CVM-4 modules

BLU-C models has integrated BVS-CU, the Control Unit that collects measurements from the CVM / CVM-4 modules. Therefore, CVM / CVM-4 modules are connected directly to the BLU-C enabling cell voltages to be monitored on BLU-C display. Connection diagram of BLU500C & 2 x CVM-4 modules (enabling monitoring up to 8 cells) is present on the diagram below.

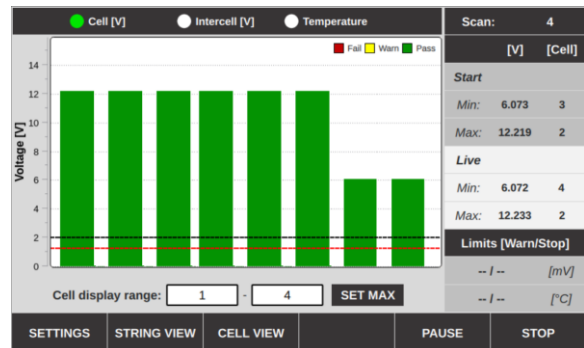

Combining BLU-C and BVR22

Battery Voltage Recorder Series BVR22 is a lightweight, user-friendly, rechargeable handheld device intended for individual battery cell voltage and temperature measurement while the battery is either in online or offline

mode. When used in a system with the BLU-C device it serves as an efficient supplement to the battery capacity testing. Options and features of the BVR22 model are presented in the table below.

	<p>Parameters Measured</p> <ul style="list-style-type: none"> - String and cell voltage, cell (electrolyte)/ambient temperature, DC current measurement using current clamps. - Simultaneous string voltage and DC current measurement - Bluetooth communication with external Density Meter <p>Measurement range</p> <ul style="list-style-type: none"> - String / Cell Voltage: ± 600 V DC - Current / Intercell voltage: ± 1 V DC <p>Data Transfer: Bluetooth and USB to PC</p>
---	--

DV-B Win Software

The DV-B Win software is included in the purchase price, and all its updates are free of charge. Using the DV-B Win software a test can be controlled, performed and observed from a PC (or notebook), and the results can be saved directly on a PC (or notebook). Communication between the BLU and a PC (or notebook) is achieved through a USB cable. Using DV-B Win the results can be arranged and printed for a report in a selectable format as an XLS, PDF,

Word, or RTF format. Also, the possibility of importing other types of data format (jpg, png, doc) into standardized DV-B Win report is provided, as well as exporting the numerical and graphical results from DV-B Win into customizable report. Additionally, the software provides a possibility of setting extra parameters (cell voltage, string voltage, capacity and time) for alarming and ending the test.

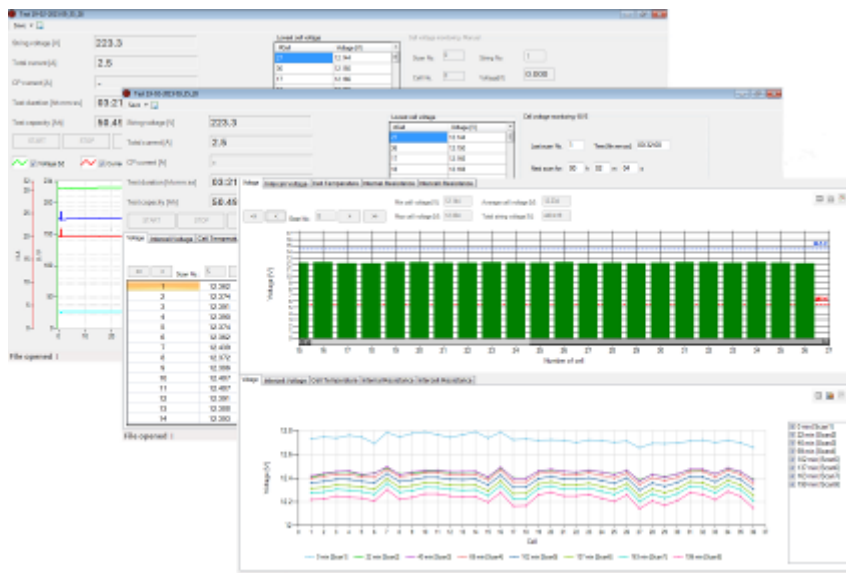

Technical Data

Mains Power Supply

- Connection according to IEC/EN60320-1; C320
- Voltage:
90 V – 264 V AC, 50 / 60 Hz, single-phase
Power interruption: 40 ms max
- Input power:
200 W (BLU-C), 400 W (BLU-C + BVS)

Dimensions and Weights

Model	Dimensions	Weight
BLU100C (without acc.)	520 x 265 x 412 mm 20.5 x 10.5 x 16.2 in	18,9 kg 41.6 lbs.
BLU200C (without acc.)	590 x 280 x 600 mm 23.2 x 11.0 x 23.6 in	28,5 kg 62.7 lbs
BLU300C (without acc.)	520 x 265 x 412 mm 20.5 x 10.5 x 16.2 in	18,9 kg 41.6 lbs.
BLU400C (without acc.)	590 x 280 x 600 mm 23.2 x 11.0 x 23.6 in	28,5 kg 62.7 lbs
BLU500C (without acc.)	520 x 265 x 412 mm 20.5 x 10.5 x 16.2 in	18,9 kg 41.6 lbs.
BLU600C (without acc.)	590 x 280 x 600 mm 23.2 x 11.0 x 23.6 in	28,5 kg 62.7 lbs
BLU570C (without acc.)	520 x 260 x 436 mm 20.5 x 10.2 x 17.1 in	20,8 kg 45.8 lbs.
BLU700C (without acc.)	590 x 280 x 600 mm 23.2 x 11.0 x 23.6 in	28,0 kg 61.7 lbs
BLU800C (without acc.)	520 x 260 x 436 mm 20.5 x 10.2 x 17.1 in	20,8 kg 45.8 lbs.
CVM	66 x 28 mm x 139 mm 2.6 in x 1.1 in x 5.5 in	0,14 kg 0.3 lbs

Measurement

Internal current measurement

Model	Range	Resolution
BLU100C	0 – 300 A DC	0,1 A
BLU200C	0 – 400 A DC	0,1 A
BLU300C	0 – 300 A DC	0,1 A
BLU400C	0 – 400 A DC	0,1 A
BLU500C	0 – 300 A DC	0,1 A
BLU600C	0 – 400 A DC	0,1 A
BLU570C	0 – 200 A DC	0,1 A
BLU700C	0 – 400 A DC	0,1 A
BLU800C	0 – 200 A DC	0,1 A

Current measurement

- Display range: 0 – 2 999,9 A DC
- Basic accuracy: $\pm (0,5 \% \text{ of reading} + 0,1 \text{ A})$
- Resolution: 0,1 A

Internal voltage measurement

Type	Range	Res.
Battery voltage	BLU100C/BLU200C/BLU300C/BLU400C: 0 – 300 V DC (0 – 500 V DC)* BLU500C/BLU600C: 0 – 500 V DC BLU570C: 0 – 570 V DC BLU700C: 0 – 700 V DC BLU800C: 0 – 800 V DC	0,1 V
Cell voltage	$\pm 30 \text{ V DC}$	1 mV
Intercell connection voltage	$\pm 50 \text{ mV DC}$	1 μV

* Provided on request

- Sampling rate: 10 Hz, values are saved when change is $>10 \text{ mV}$

Typical voltage measurement accuracy

- For BLU-C:
 $\pm 0,5\% \text{ of reading} \pm 0,1 \text{ V (0 - 800 V DC)}$
- For BVS:
 $\pm 50 \text{ mV DC: } \pm (1\% \text{ rdg} + 1\% \text{ F.S})$
 $\pm 1 \text{ V DC: } \pm (0,1\% \text{ rdg} + 0,1\% \text{ F.S})$
 $\pm 30 \text{ V DC: } \pm (0,1\% \text{ rdg} + 0,1\% \text{ F.S})$

Time measurement

- Typical accuracy:
 $\pm 0,1\% \text{ of reading} \pm 1 \text{ digit}$

Display

Size

- 7 inch color touch screen display

Range / Resolution

- Current: 0 – 2 999,9 A DC / 0,1 A
- Voltage: 0 – 999,9 V DC / 0,1 V
- Capacity: 0 – 9999,9 Ah / 0,1 Ah
- Time: 00h:00m:00s - 23h:59m:59s / 1 sec

Input for current probe

- Range: 0 – 1000 mV DC
- mV/A-ratio: 0 – 100 mV / A
- Input impedance: > 1 MΩ

Communication with PC

- USB
- RS232 (optional)
- Ethernet (optional)

Load section

- Battery voltage
5,25* – 300 V: BLU100C/ BLU200C,
BLU300C/ BLU400C
5,25* – 500 V: BLU500C/ BLU600C
5,25* – 570 V: BLU570C
3,0* – 700 V: BLU700C
5,25* – 800 V: BLU800C
* Total discharge down to 0 V available with ZVD module
- Power:
BLU100C/ BLU300C/ BLU500C: 20 kW (max)
BLU200C/ BLU400C/ BLU600C/ BLU700C:
42 kW (max)
BLU570C: 30 kW (max)
BLU800C: 32 kW (max)
- Discharge modes:
Constant current / power / resistance; current,
power or resistance profile mode

Constant current (Const I)

Model	Range
BLU100C	0 – 150 A DC (20 kW)*
BLU200C	0 – 300 A DC (42 kW)*
BLU300C	0 – 220 A DC (20 kW)*
BLU400C	0 – 300 A DC (42 kW)*
BLU500C	0 – 220 A DC (20 kW)*
BLU600C	0 – 300 A DC (42 kW)*
BLU570C	0 – 100 A DC (30 kW)*
BLU700C	0 – 260 A DC (42 kW)*
BLU800C	0 – 100 A DC (32 kW)*
ZVD module	0 – 60 A

* Maximum discharge power

Typical accuracy: ± (0,5% of reading + 0,2 A)

- Resolution: 0,1 A
- Ripple: max ±0,4 A peak

Constant resistance (Const R)

Model	Resistance
BLU100C	0,1 – 3 000 Ω
BLU200C	0,1 – 3 000 Ω
BLU300C	0,1 – 3 000 Ω
BLU400C	0,1 – 3 000 Ω
BLU500C	0,1 – 5 000 Ω
BLU600C	0,1 – 5 000 Ω
BLU570C	0,2 – 5 700 Ω
BLU700C	0,1 – 7 000 Ω
BLU800C	0,2 – 8 000 Ω

- Typical accuracy: ± 1%
- Resolution: up to 0,01 Ω

Constant power (Const P)

Model	Range	Res. (max)
BLU100C	0 – 20 kW*	0,01 kW
BLU200C	0 – 42 kW*	0,01 kW
BLU300C	0 – 20 kW*	0,01 kW
BLU400C	0 – 42 kW*	0,01 kW
BLU500C	0 – 20 kW*	0,01 kW
BLU600C	0 – 42 kW*	0,01 kW
BLU570C	0 – 30 kW*	0,01 kW
BLU700C	0 – 42 kW*	0,01 kW
BLU800C	0 – 32 kW*	0,01 kW

* Instrument max. power derates at temperatures over +35°C (+95°F).

- Typical power accuracy measurement: ±1%
- Ripple: max 0,2 kW

Available languages

- English, German

Warranty

- 3 years + additional 1 (one) year upon registration on DV Power official website (www.dv-power.com).

STOP parameters

- Battery voltage
- Capacity
- Test time

Environment conditions

- Operating temperature:
0°C to +50 °C / 32 °F to +122 °F
- Storage & Transportation temperature:
-40 °C to +70 °C / -40 °F to +158 °F
- Relative humidity: 0 - 95%, non-condensing
- Altitude: up to 3000 m
- Pollution degree: 2* **

* BLU-C should be operated in well conditioned indoor environment.

** Additional protective coating can be applied to BLU-C internal components, reducing the possibility of oxidation and salt accumulation. The additional protective coating is recommended if BLU-C might be used or stored in high air salinity or high air acidity environment.

Shock/Vibration/Fall

- Instrument: ETSI EN 300 019-2-7 class 7M2
- Instrument in transport case: ISTA 2A

Applicable Standards

- IEEE 450-2010, IEEE 1188-2005, IEEE 1106-2015, IEC 60896-11, IEC 60896-22 and other relevant standards
- Electromagnetic Compatibility:
- Directive 2014/30/EU (CE conform)
Applicable standard: EN 61326-1
- CAN/CSA-C22.2 No. 61010-1

Protection

- Thermal cut-outs and automatic overload protection
- Emergency Stop button
- Overcurrent, overheat and overvoltage protection

Current probe specifications

Current probe	Ranges	mV/A – ratio	Supply
Current clamp 30/300 A*	30 A	10 mV / A	From the instrument
	300 A	1** mV / A	

* 1 000 A current clamp can be provided on request.

** 0.1 mV/A can be provided on request

Encapsulation class / Ingress protections

- IP20
- Safety
 - Low Voltage Directive:
Directive 2014/35/EU (CE conform)
 - Applicable standards, for a class I instrument, pollution degree 2,
Installation category II: IEC EN 61010-1

All specifications herein are valid at ambient temperature of + 25 °C /+ 77°F and recommended accessories. Specifications are subject to change without notice.

Accessories



Current cables



Extension cables

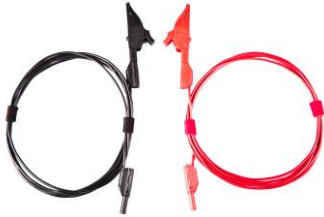

Sense cables with dolphin clips



Current clamp 30/300 A



Zero Voltage Discharge Module ZVD



Cell Voltage Module CVM-4



Transport case for BLU100C / BLU300C / BLU500C



Transport case for BLU200C / BLU400C / BLU600C / BLU700C



Transport case for BLU570C / BLU800C



Cable bag

Order Info

Instrument	Article No
Battery Load Unit BLU100C	BLU100C-N-01
Battery Load Unit BLU200C	BLU200C-N-01
Battery Load Unit BLU300C	BLU300C-N-01
Battery Load Unit BLU400C	BLU400C-N-01
Battery Load Unit BLU500C	BLU500C-N-01
Battery Load Unit BLU570C	BLU570C-N-01
Battery Load Unit BLU600C	BLU600C-N-01
Battery Load Unit BLU700C	BLU700C-N-01
Battery Load Unit BLU800C	BLU800C-N-01

Included accessories
Windows based DV-B Win PC software including USB cable
Mains Power cable
Ground (PE) cable
Transport case with wheels

Standard accessories	Article No
Current cables 2 x 3 m 35 mm ² (9.84 ft, 2 AWG) with alligator clamps (A4) isolated (for <i>BLU100C</i> model)	C2-03-35VA4I
Current cables 2 x 3 m 50 mm ² (9.84 ft, 0 AWG) with alligator clamps (A4) isolated (for <i>BLU300C</i> , <i>BLU500C</i> and <i>BLU700C</i>)	C2-03-50VA4I
Current cables 2 x 3 m 70 mm ² (9.84 ft, 00 AWG) with alligator clamps (A4) isolated (for <i>BLU200C</i> , <i>BLU400C</i> and <i>BLU600C</i>)	C2-03-70VA4I
Current cables 2 x 3 m 25 mm ² (9.84 ft, 4 AWG) with alligator clamps (A4) isolated (for <i>BLU570C</i> and <i>BLU800C</i>)	C2-03-25VA4I
Cable bag	CABLE-BAG-00

Optional accessories	Article No
Zero Voltage Discharge Module ZVD	BLU-ZVDMxx-0
Battery External Load Unit BXL-A	BXL400X-A-00
Battery External Load Unit BXL-V	BXL400X-V-00
Cell Voltage Module CVM	BVS-CVMNC-00
Cell Voltage Module CVM-4	BVS-CVM4N-00
Current cables 2 x 5 m xx mm ² with alligator clamps (A4)	C2-05-xxVA4I
Current cables 2 x 10 m xx mm ² with alligator clamps (A4)	C2-10-xxVA4I
Extension current cables 2 x xx m xx mm ² (xx ft, xx AWG)	E2-xx-xxVA3I
Sense cables 2 x xx m (xx ft) with banana plugs + dolphin clip	S2-xx-00BPDC
Current clamp 30/300 A power supplied from the instrument	CACL-0300-06
Current clamp 1000 A with internal battery supply and adapter	CACL-1002-02
Cable for BLU-BLU parallel operation 3 m (9.84 ft)	CP-0003N6-00
Cable set for BLU-BXL simultaneous triggering	PO-02-01BPBP
PT100 temperature indicator	TI-000-PT100
Additional protective coating from polluted environment for BLU Series	BLU-PCOAT-00

IBEKO Power AB

Lejonstigen 9
181 32 Lidingö, Sweden

Contact

Phone: +46 70 0925 000
E-mail: sales@dv-power.com